

BASIN TAP WA100



Ø 52 x 171 x 155 mm

Normal pressure

- Single-lever basin tap without waste fitting in robust, germ-reducing and easy-care stainless steel (AISI 303).
- Version: normal pressure. Operating pressure 2–6 bar.
- Solid stainless steel body; visible surfaces satin finished. Further available surfaces: see below.
- High quality ceramic mixer cartridge with adjustable temperature limit setting (scald protection).
- Neoperl® air bubble spray M21 x 1 mm.
- Design height: 171 mm
Outlet height: 87 mm
Projection: 98 mm
Length of lever: 40 mm
- Wear parts can be replaced as modules.
- Installation dimensions: Ø 33-40 mm
Surface thickness max. 40 mm
- Mounting: With one counternut.
- Delivery includes fixing material and two flexible connecting hoses clad in stainless steel.
- Weight, including single package: 1.4 kg



Suggested text for specifications:

Single-lever basin tap in stainless steel (AISI 303) for counter mounting. Version: normal pressure. Solid stainless steel body; visible surfaces satin finished. Ceramic mixer cartridge with adjustable temperature limit setting. Delivery includes fixing material and two flexible connecting hoses clad in stainless steel.

Dimensions: Ø 52 x 171 x 155 mm

Outlet height 87 mm

Projection 98 mm

Length of lever 40 mm

Article No. WA100

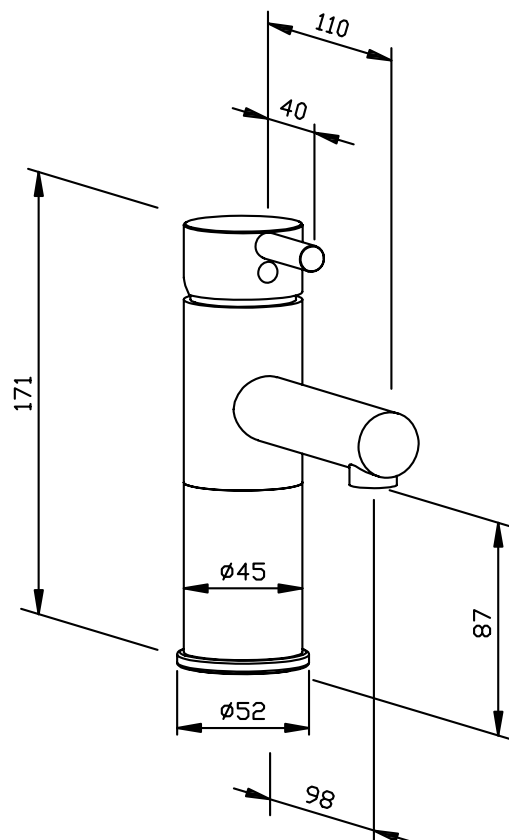

Available surfaces	ID No.
satin finished (standard)	924 266
highly polished	931 266

Ernst Wagner GmbH & Co. KG

Ernst-Abbe-Straße 21 · D-72770 Reutlingen · Tel.: +49712151539-0 · Fax: -20
info@wagner-ewar.de · www.wagner-ewar.de

WAGNER
EWAR